

Data Sheet



Article number: 2304037741

Description: E+G Tubular handle
M.1043/30-600-EP

Measures

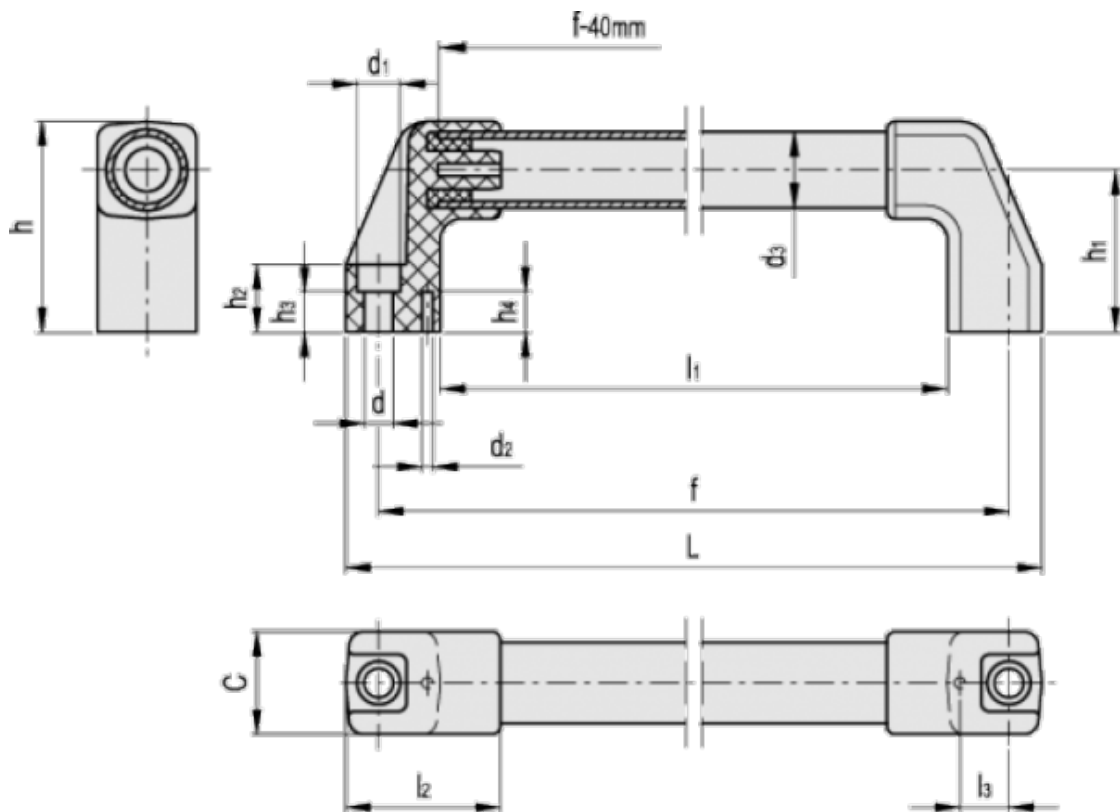

c	= 38	h1 = 60	R = load at breakage in N = 2000
d	= 10.5	h2 = 25	
d1	= 16	h3 = 15	
d2	= 4	h4 = 15	
d3	= 30	L = 624	
E = Max . working load in N = 1600		l1 = 554	
f	= 600	l2 = 57	
h	= 78	l3 = 18	